



Product / Technical Information

# LIGHTING THE FUTURE

## STANDARD AND HIGH PERFORMANCE AUTOMOTIVE HALOGEN BULBS



## HELLA BULBS

Standard and High Performance



### A vision of the future

HELLA has been setting innovative milestones and is inextricably linked to the development of the car.

Lighting technology is one of our core business areas and the company stands proud as a recognised worldwide leader in this field.

HELLA represents not only innovation but outstanding quality, intelligent design and lighting performance - all crucial safety factors when considering the wide product range on offer.

HELLA, a brand that offers so much more.

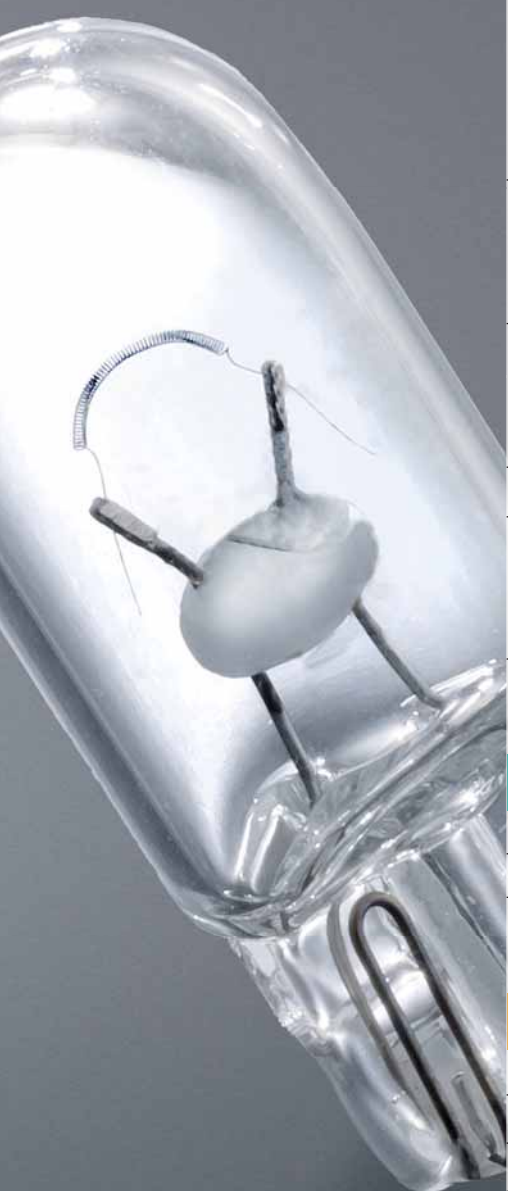

## CONTENTS

<b>LIGHT SOURCES</b>	<b>4</b>
Basic lighting terms	5
Filament and halogen bulbs	6
Functioning	
Light sources	
Filament bulb	
Standard halogen bulbs	
Main components of halogen bulbs	7
Cyclic process inside a halogen bulb	
Influencing factors on a bulb	
High Intensity Discharge Bulbs (HID)	8
Functioning	
Main components of High Intensity Discharge bulbs	
Halogen / Xenon technology comparison	9
Colour temperature	10
Life expectancy of a bulb	
Replacement and installation	
Tested quality	11
<b>BULBS SUMMARY - PRODUCT RANGE</b>	<b>12</b>
Halogen standard bulbs	14
Miniature bulbs	15
High Intensity Discharge bulbs (HID)	19
<b>HIGH PERFORMANCE AUTOMOTIVE BULBS</b>	<b>20</b>
Long Life	22
Night Vision +	23
Platinum +50	24
Daymaker +80	25
Xenon Blue	26
High Performance Bulb range	27

## LIGHT SOURCES



Sight is the most important sense for safety in road traffic. This can be impaired under certain circumstances, e.g. at twilight, in adverse weather conditions, by soiled windscreens etc. Therefore, the risk of an accident is comparatively high under such driving conditions.

The changing and continually increasing mobility and traffic density linked to this represent a further potential hazard. To meet these challenges successfully, work is continually being done on improving existing lighting systems as well as developing new technical lighting equipment.

### Dear customer:

This HELLA Standard and High Performance Bulbs brochure, provides a technical specification overview.

We have also included specific technical reference applicable to our standard and high performance bulb range.

HELLA covers a wide range of applications for all kinds of vehicles; passenger cars, trucks, special purpose vehicles and motorbikes. HELLA's vast range includes headlights, sundry

lights, interior lighting, classical halogen light as well as xenon light and all available at attractive prices.

We trust you will find this brochure informative and enhance your understanding of how HELLA Standard and High Performance Bulbs function.

**Your HELLA Automotive  
South Africa Team**

# LIGHT SOURCES

## BASIC LIGHTING TERMS



Here is a summary of the most important basic terms in lighting technology and the respective units of measure for bulb and light evaluation.

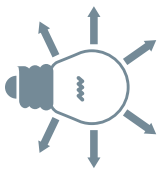

### Luminous flux $\Phi$

Unit: Lumen [lm]

Luminous flux  $F$  is the term used to describe the complete light output radiated from a light source.

### Light output $\eta$

Unit: Lumen per Watt [lm/W]

Light output  $h$  specifies the rate of efficiency with which the consumed electrical power is transformed into light.



### Luminous intensity $I$

Unit: Candela [cd]

Part of the luminous flux which radiates in a certain direction.

### Light sources

Light sources are radiators of temperatures which produce light through heat energy. This means the more strongly a light source is heated up, the higher its luminous intensity will be.

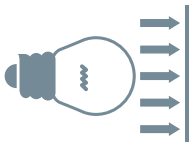

### Illuminance $E$

Unit: Lux [lx]

Illuminance  $E$  specifies the ratio of the impinging luminous flux to the illuminated surface. Illuminance is 1 lx when a luminous flux of 1 lm impinges an area of 1 m<sup>2</sup>.

The low efficiency (8 % light radiation) only allows a relatively low light output in comparison with gas discharge lamps (28 % light radiation). Recently, LEDs have started to be used as light source in front headlights.



### Luminance $L$

Unit: Candela per square metre [cd/m<sup>2</sup>]

Luminance  $L$  is the impression of brightness the eye has from a luminous or illuminated surface.

## LIGHTING THE FUTURE

### STANDARD AUTOMOTIVE HALOGEN BULBS

As a technological leader in the field of intelligent light distribution, (be it halogen, xenon or full-LED headlights) and as a partner to renowned international vehicle manufacturers, HELLA always fulfills the highest expectations in product quality and performance.

**A bulbs range benchmark is: top technology with no compromise in quality, founded on rigorous testing. This means optimum visibility thanks to top light quality and minimum failure rates thanks to durable and long lasting products.**

#### FUNCTIONING

The lighting system of a motor vehicle consists of lighting and signalling devices mounted or integrated to the front, sides, rear, and in some cases the top of the motor vehicle. The purpose of this system is to provide illumination for the driver to operate the vehicle safely after dark, increase vehicle visibility, display information about the vehicle's presence, position, size, direction of travel and driver's intentions regarding direction and speed of travel.

A bulb can be considered as a replacement part with a limited service life. Yet the bulb is part of the lighting system. It is an active component of a unit where all the elements should be perfectly matched to one another.

#### LIGHT SOURCES

Light sources are thermal radiators which convert heat energy into light. This means that the hotter a light source is, the higher the luminous intensity.

#### FILAMENT BULB

Filament bulbs (vacuum bulbs) are thermal radiators and the supply of electric energy makes a tungsten filament glow. Generally, the light output of a standard bulb is low. Additionally, evaporated tungsten particles considerably blacken the bulb (see photograph below) and reduce all lighting values as well as service life.



New filament bulb (left) and old blacken filament bulb (right).

#### STANDARD HALOGEN BULBS

By adding small amounts of halogen atoms such as iodine, the blackening of the bulb is reduced. The so-called "cyclic process" enables operation of halogen bulbs at higher temperatures and thus with improved efficiency with the same useful life.

There are basically two different types of halogen bulbs available. The types H1, H3, H7, H9, H11, HB3 and HB4 only have one filament. They are used for low beam and high beam. In comparison to H1 bulbs, H7 bulbs have a higher luminance, lower power consumption and better light quality. The second type is the H4 bulb with two filaments, one for low beam and one for high beam.



Standard halogen bulb, type H4

# LIGHT SOURCES

## HALOGEN BULB - MAIN COMPONENTS

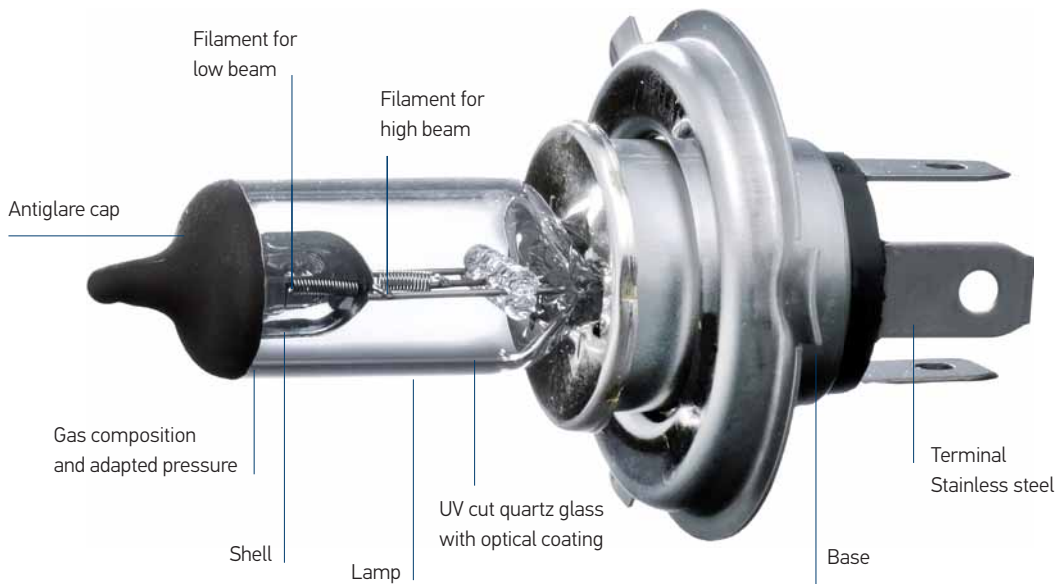

H4 Type Bulb

The filament for low beam is fitted with a shell. This has the purpose of covering the dazzling share of the light and producing the cut-off pattern.

### CYCLIC PROCESS INSIDE A HALOGEN BULB

Supply of electronic energy makes the filament glow and metal evaporates off the filament. A halogen filling (iodine or bromine) inside the bulb lets the filament temperature rise to near the melting point of the tungsten (around 3 400°C) and this causes the high light output. In the immediate vicinity of the hot bulb wall, the evaporated tungsten combines with the filling gas (tungsten halogenide) to form a gas which is transparent.

However, once the gas gets back near the filament, it disintegrates due to the high filament temperature and forms an even tungsten layer. For the cyclic process to stop, the outer temperature of the bulb must be 300°C. The bulb made of quartz glass must closely enclose the filament.

Another advantage is that a higher filling pressure can be used to counteract the evaporation of the tungsten. The gas composition in the bulb is also a major factor controlling the light output. Inclusion of a small amount of a noble gas such as xenon reduces the heat

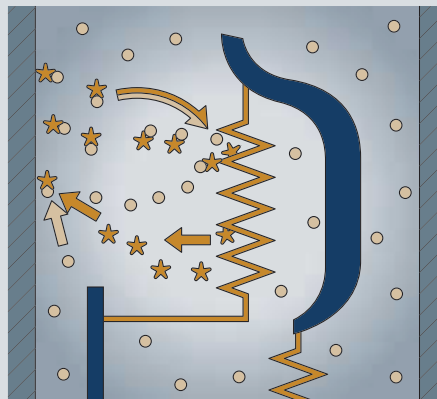

- 1 Tungsten filament
- 2 Halogen filling (iodine or bromine)
- 3 Evaporated tungsten
- 4 Tungsten halogenide
- 5 Tungsten deposits

transfer away from the filament. However, despite the regeneration process inside the bulb, the tungsten filament is slowly consumed and thus service life is limited.

### INFLUENCING FACTORS ON A BULB

#### Negative influencing factors

- Mechanical stress due to impacts and vibration
- High temperatures
- Switching-on process
- Glitches and excessive on-board voltage
- High luminance due to extreme filament density

#### Positive influencing factors

- Filling pressure
- Filling gas

#### Cross-section of temperature zones

Cross-section through the temperature (°C) zones of a halogen bulb.

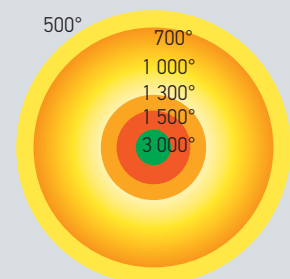

Top view - Lamp

# LIGHT SOURCES

## HIGH INTENSITY DISCHARGE BULBS (HID)

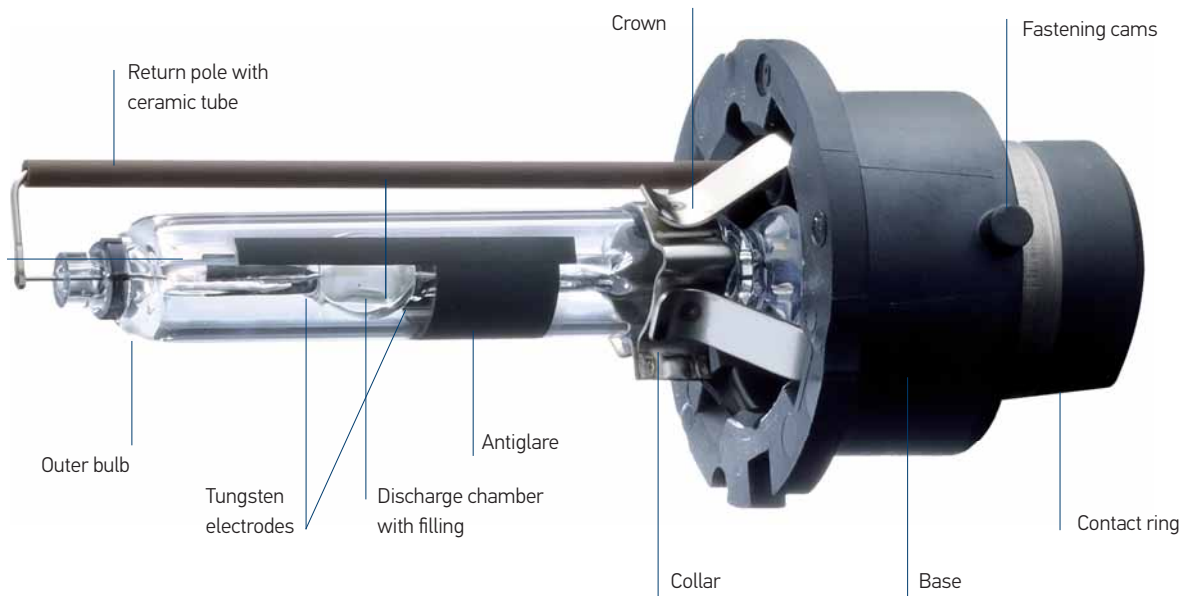

Luminance cd / cm<sup>2</sup>

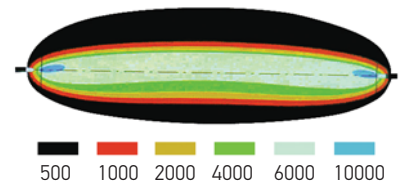

### D2R Bulb (HID)

#### FUNCTIONING

High-intensity discharge (HID) headlamps use the physical principle of electric discharge and produce light with an electric arc rather than a glowing filament. The high intensity of the arc comes from metallic salts that are vaporized within the arc chamber. An ignition voltage (up to 23 kV in the case of 3rd generation electronic ballasts) ionises the gas between the bulb's electrodes and makes the bulb glow based on an arc.

During the controlled supply of an alternating current (around 400 Hz) the liquid and solid matter in the discharge chamber evaporate due to the high temperatures. To prevent destruction of the lamp through uncontrolled increases in current, the current is limited by a ballast. Once the full light output has been reached, an operating voltage (not the ignition voltage) of only 85 V is necessary to keep up the physical process.

Automotive HID lamps were introduced in 1991. They are commonly called "xenon

headlamps", though they are actually metal halide lamps that contain xenon gas.

The xenon gas allows the lamps to produce minimally adequate light immediately upon power up, and accelerates the lamps' run-up time. However the full intensity is reached 20 to 30 seconds later once the salts of sodium and scandium are vaporized by the heat of the xenon arc.

HID bulbs produce more light for a given level of power consumption than ordinary tungsten and tungsten-halogen bulbs. Because of the increased amounts of light available from HID bulbs relative to halogen bulbs, HID headlamps producing a given beam pattern can be made smaller than halogen headlamps producing a comparable beam pattern.

Alternatively, the larger size can be retained, in which case the xenon headlamp can produce a more robust beam pattern.

The lamp envelope is small and the arc spans only a few millimeters.

An outer hard glass tube blocks the escape of ultraviolet radiation that would tend to damage plastic headlamp components.





# LIGHT SOURCES

## HIGH INTENSITY DISCHARGE BULBS (HID)

### Comparison between filament bulb (halogen) / light arc gas discharge lamp (xenon)

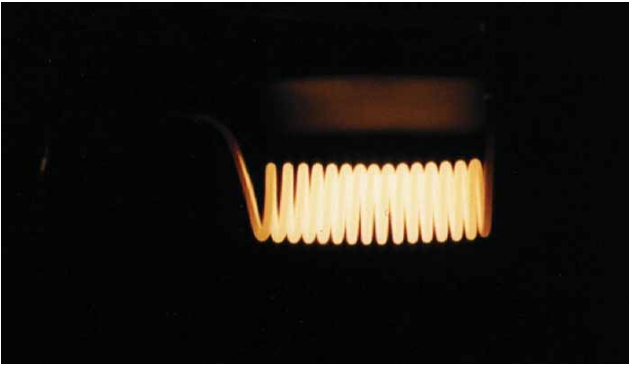

Typical light distribution and colour temperature of a light beam with standard halogen bulb.

Typical light distribution and colour temperature of a light beam with HID bulb.

	Halogen bulb (H1)	Gas discharge lamp (Xenon D1S)
Light source	Filament	Light arc
Luminous flux	1550 lm	3200 lm
Luminous intensity	1450 cd/m <sup>2</sup>	3000 cd/m <sup>2</sup>
Capacity	55 W	35 W
Energy balance	8 % light radiation 92 % heat radiation	28 % light radiation 58 % heat radiation 14 % UV radiation
Service life	approx. 500 h	2,500 h
Vibration-proof	to a certain extent	yes
Ignition voltage	no	yes 23,000 V (3rd generation)
Electronic control	no	yes
Kelvin Temperature (Daylight ± 6000 K)	3200 K	4150 K (Projection system)

# LIGHT SOURCES

## COLOUR TEMPERATURE

Colour temperature is a measurement in degrees Kelvin that indicates the hue of a specific type of light source. (Kelvin is indicated by the unit symbol K.)

Colour temperatures over 4000K are called cool colours (blueish white), while lower colour temperatures (2700 – 3000K) are called warm colours (yellowish white through red).

The higher the temperature of a light source is, the greater the proportion of blue and the lower the proportion of red in the colour spectrum. An incandescent light bulb has a warm white colour temperature of approx. 2700K.

The illustration below provides an indication of the colour temperature spectrum.

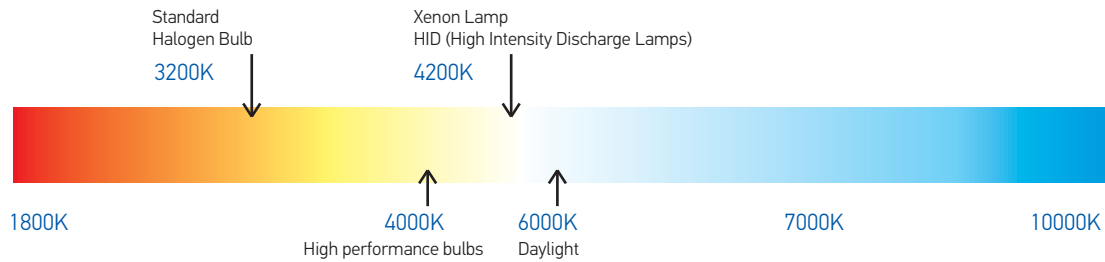

### LIFE EXPECTANCY OF A BULB

Service life and light efficiency among other things strongly depend on the supply voltage used.

Therefore, protective resistors are used in some vehicle types to ensure that the supply voltage doesn't exceed 13.2 V. On the other hand, undervoltage, e.g. due to a defective generator, means exactly the opposite. The light now has a considerably higher red fraction and thus light efficiency is lower.

LIFE EXPECTANCE DEPENDENT ON VOLTAGE

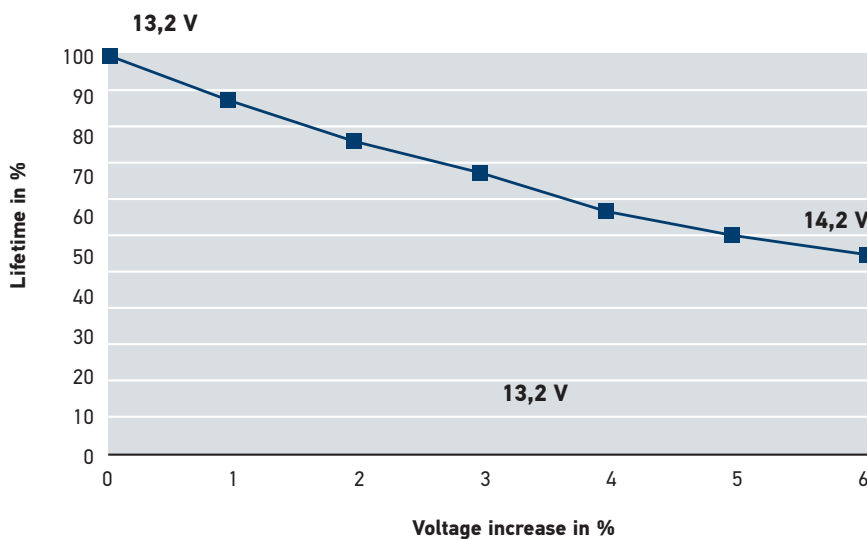

**Rule of thumb:** If the supply voltage of a bulb is increased by 5%, then the luminous flux increases by 20%, but at the same time service life is halved.

### REPLACEMENT AND INSTALLATION

- When inserting a new bulb, you should not touch the glass bulb, because fingerprints may burn in and leave "clouds" on glass
- Standard filament and halogen bulbs do not contain environmentally relevant substances and can be disposed of as household waste
- Check the local regulations to ensure correct disposal
- HELLA recommend to replace both bulbs when a bulb has blown



## LIGHT SOURCES TESTED QUALITY

All HELLA bulbs undergo thorough testing. The engineers in HELLA's Quality Assurance department have specified a clear requirement profile for every bulb type.

Headlight bulbs, are tested by our engineers for their light distribution properties. The very latest in light measuring equipment is used for this. Paint adhesion tests in accordance with FAKRA guidelines (German Association of Automotive Experts), vibration and shock tests in line with IEC requirements, geometry measurements, light flux and power measurements as well as service life tests guarantee that wholesalers and garages receive perfect quality.

Quality assurance is very important to us. Thanks to the extensive tests and our knowledge as an OE lighting expert, you can trust that we guarantee you top quality.

As a result of this consistent quality testing, renowned vehicle manufacturers have been relying on our technological innovations for years and trust HELLA expertise, experience and quality.

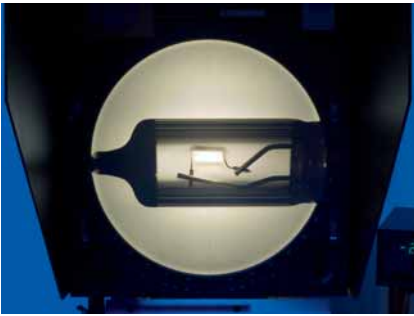

### Geometrical Measurement

A measuring projector is used to check the filament geometry - with regard to the statutory standards in accordance with IEC 60810. The filament must be dimensioned and positioned within the bulb as specified in the standard. This is the only way to achieve optimum headlight power and prevent glare to oncoming traffic.



### Vibration and Shock Test

Here, vibration resistance of the bulb and the filament in particular, is tested on an electro-dynamic vibration table.



### Paint Adhesion Test

The adhesion of paint on coloured glass bulbs – such as the PY21W for example – is tested in a climate chamber at different temperatures and air humidities. Optimum adhesion of glass bulb paint guarantees the prescribed amber indicator light over the whole service life period.



### Life Test

Sophisticated tests are used to prove the high reliability of the HELLA bulbs over a long period.



### Light Flux Measurement

The Ulbricht sphere and goniometer are used to determine the light fluxes and luminous intensities of the HELLA bulbs. This guarantees optimum light output of the bulbs.

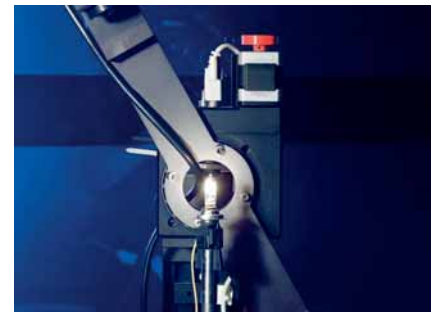

The aforementioned tests and measurements form the basis of our tested quality.

# BULBS SUMMARY

## PRODUCT RANGE - FOR CARS AND TRUCKS

Low Beam

High Beam

Fog Light

### HEADLIGHT STANDARD BULBS

XENON (HID)	<b>D1S</b> G8021	<b>D2S</b> G7949	<b>D2R</b> G7001	<b>H1</b> G1904 24 V G1905	<b>H2</b> G5712 24 V G5724	<b>H3</b> G1907 24 V G1908	<b>H4</b> G12342 24 V G13342	<b>H7</b> G1785 24 V G1786	<b>H8</b> G5151	<b>H9</b> G64213	
	<b>D3S</b> G9028	<b>D4S</b> G9301									
HALOGEN				<b>H11</b> G1781	<b>HB3</b> G5081	<b>HB4</b> G5091	<b>H15</b> G9001	<b>R2</b> G8131 24 V G8251			

Front Indicator

Rear Indicator

### INDICATOR LIGHT

<b>P21W</b> G382	<b>PY21W</b> G1121	<b>P27W</b> G5882	<b>P27/7W</b> G5872 <span style="background-color: red; color: white; padding: 2px;">COMING SOON</span>	<b>H21W</b> G7010 24 V G7012
<b>WY5W</b> G4541	<b>W21W</b> G6014	<b>WY21W</b> G1002	<b>Bulb, K</b> G1131	<b>W5W</b> G1790 24 V G1788

LICENSE PLATE LIGHT

<b>T4W</b> G7121 24 V G7241	<b>W3W</b> G4141 24 V G1793	<b>C5W</b> G2121 24 V G2241
<b>R5W</b> G207 24 V G1304	<b>R10W</b> G613 24 V G618	<b>Bulb, M</b> G4121

REVERSING LIGHT

<b>P21W</b> G382 24 V G13422	<b>W21W</b> G6014
<b>Bulb, K</b> G1251	

DASH LIGHT

<b>Bulb, 1.2W</b> G1791 24 V G1792	<b>Bulb, 1.2W with clip</b> G7071
---	--------------------------------------

TAIL / PARK LIGHT

<b>P21/4W</b> G1789	<b>P21/5W</b> G1142 24 V G334	<b>R5W</b> G207 24 V G1304
<b>W21W</b> G6014	<b>W21/5W</b> G6017	<b>R10W</b> G613 24 V G618

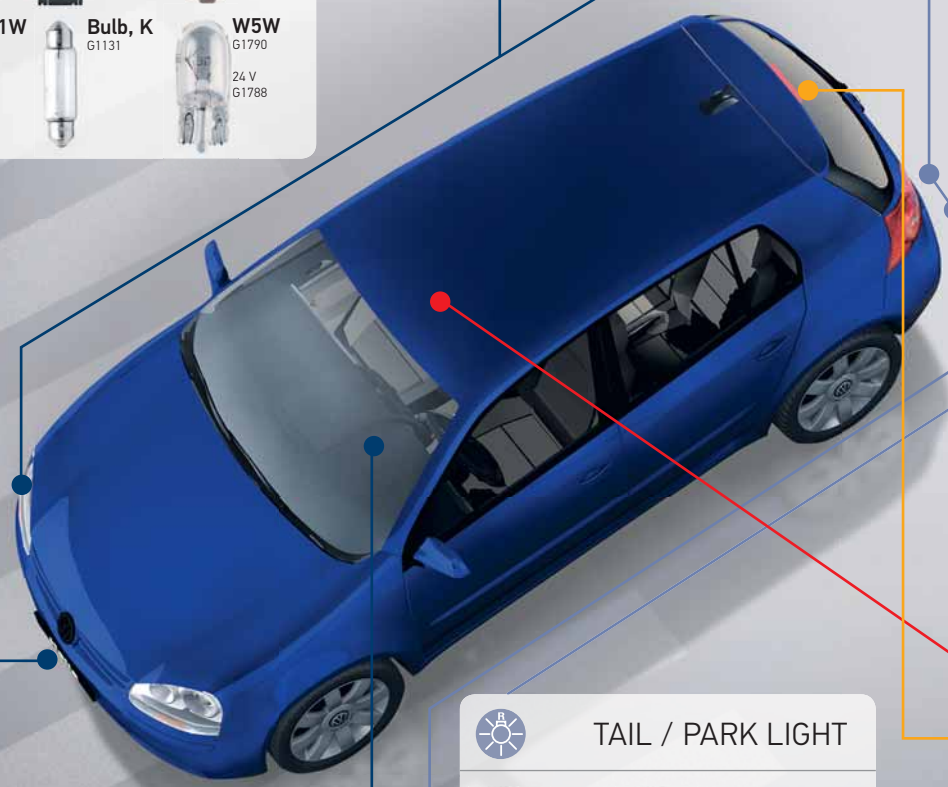



HALOGEN

HEADLIGHT

12V - HELLA HIGH PERFORMANCE BULBS

NIGHT VISION +

3000K



XENON BLUE

4000K



PLATINUM +50

3200K



DAYMAKER +80

3500K



LONG LIFE

3200K

24 V - HELLA HIGH PERFORMANCE BULBS

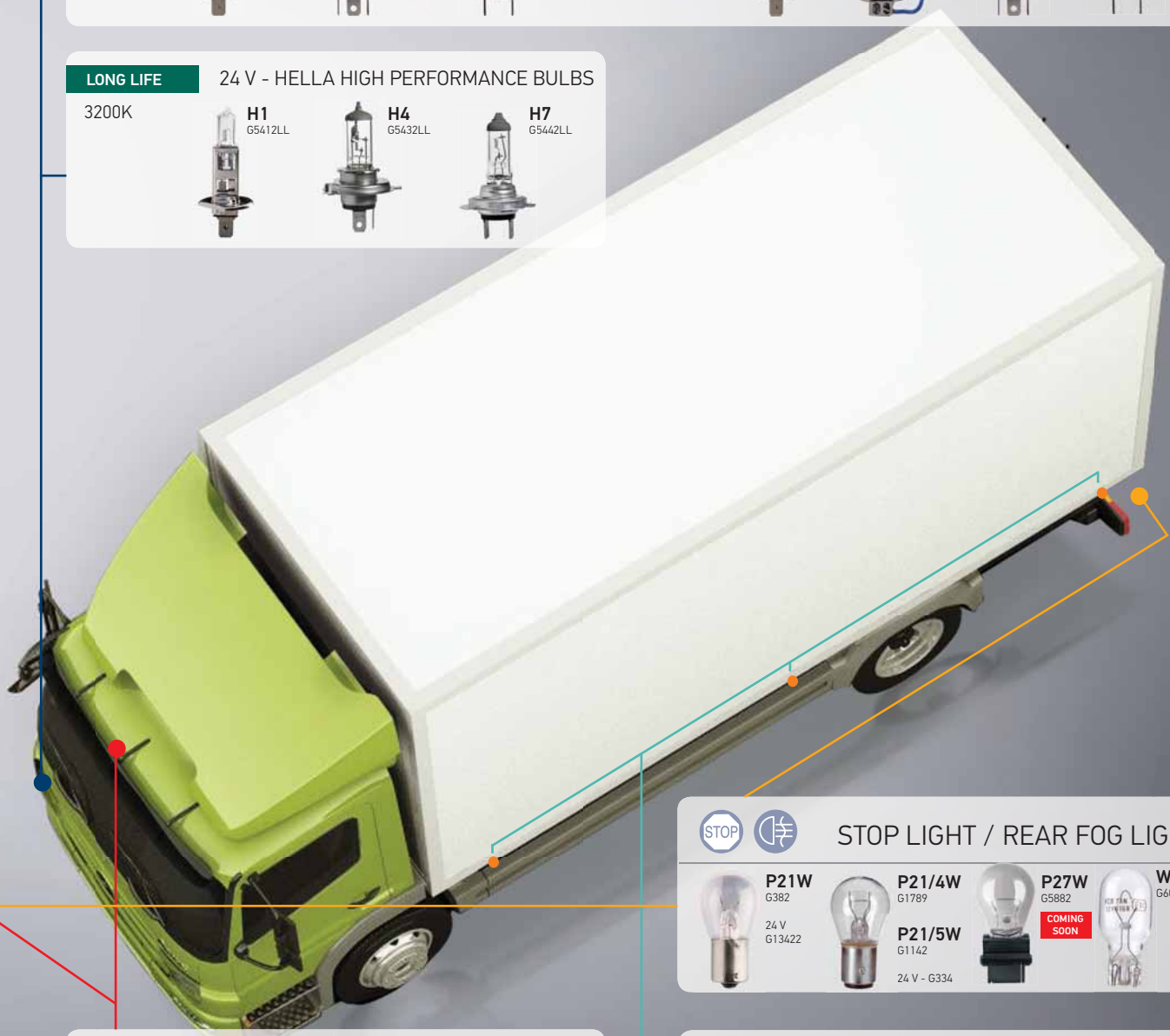

STOP LIGHT / REAR FOG LIGHT



INTERIOR LIGHT



SIDE MARKER







# STANDARD BULBS SUMMARY

## FOR CARS AND COMMERCIAL VEHICLES

Product photo / Dimensional drawing	Category	Base	Power	Voltage	Luminous flux (lumen)	Part number	Short Code	
	H1	P14.5s	55 W	12 V	1,550 lm	8GH 178.555-031	G1904	
			70 W	24 V	1,900 lm	8GH 178.555-141	G1905	
		Fog light, high beam, low beam in the 4-headlight system						
	H3	PK22s	55 W	12 V	1,450 lm	8GH 178.555-061	G1907	
			70 W	24 V	1,750 lm	8GH 178.555-241	G1908	
		Fog light, high beam, work light						
	H4	P43t	60/55 W	12 V	1,450 lm	8GJ 178.555-001	G12342	
			75/70 W	24 V	1,750 lm	8GJ 178.555-201	G13342	
		High beam, low beam						
	H7	PX26d	55 W	12 V	1,500 lm	8GH 178.555-011	G1785	
			70 W	24 V	1,500 lm	8GH 178.555-251	G1786	
		High beam, low beam in the 4-headlight system as fog light						
	H8	PGJ19-1	35 W	12 V	800 lm	8GH 178.555-151	G5151	
			High beam, low beam, fog light					
		High beam, low beam, fog light						
	H9	PGJ19-5	65 W	12 V	2,100 lm	8GH 178.555-161	G64213	
			High beam in the 4-headlight system, work light					
		High beam in the 4-headlight system, work light						
	H11	PGJ19-2	55 W	12 V	1,350 lm	8GH 178.555-111	G1781	
			Low beam in the 4-headlight system					
		Low beam in the 4-headlight system						

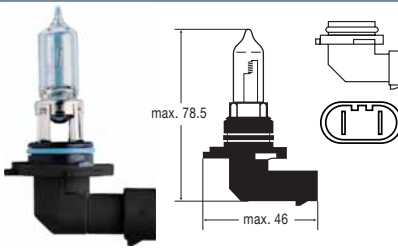
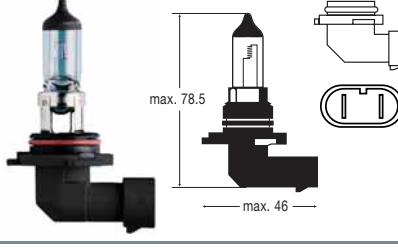
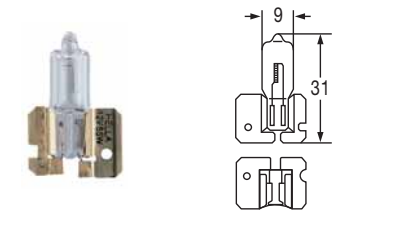
# STANDARD BULBS SUMMARY

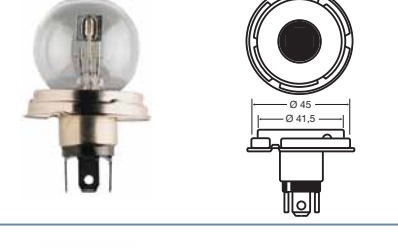
## FOR CARS AND COMMERCIAL VEHICLES

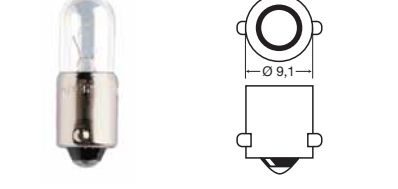
Product photo / Dimensional drawing	Category	Base	Power	Voltage	Luminous flux (lumen)	Part number	Short Code
	HB3	P20d	60 W	12 V	1,900 lm	8GH 178.555-081	G5081
		High beam in the 4-headlight system					
	HB4	P20d	51 W	12 V	1,100 lm	8GH 178.555-091	G5091
		Low beam in the 4-headlight system					
	H2	X511	55 W	12 V	1,800 lm	8GH 002.857-121	G5712
			70 W	24 V	2,150 lm	8GH 002.857-241	
Driving light, fog light, spotlight							
	H15	PGJ 236t-1	55/15 W	12 V	1,330/200 lm	8GJ 168.119-001	G9001
		High beam, low beam in the 4-headlight system as fog light					
	R2	P45t	45/40 W	12 V	1,030/740 lm	8GD 002.088-131	G8131
			55/50 W	24 V	-	8GD 002.088-251	
For asymmetrical R2 headlights, spotlights							
	H6W	BAX9s	6 W	12 V	125 lm	8GH 007.643-121	G3121
		Headlamp position light, daytime running light					
	T4W	BA9s	4 W	12 V	35 lm	8GP 002.067-121	G7121
			4 W	24 V	35 lm	8GP 002.067-241	
Sidelight							

# STANDARD BULBS SUMMARY

## FOR CARS AND COMMERCIAL VEHICLES

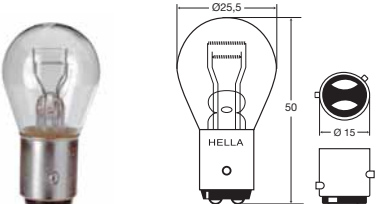
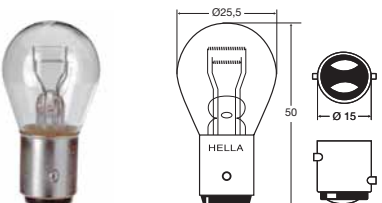
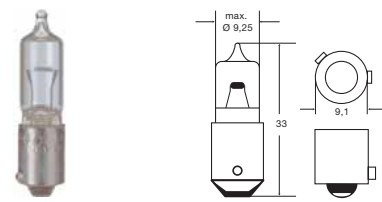
Product photo / Dimensional drawing	Category	Base	Power	Voltage	Luminous flux (lumen)	Part number	Short Code	
	P21W	BA15s	21 W	12 V	460 lm	8GA 178.560-011	G382	
			21 W	24 V	460 lm	8GA 178.560-101	G13422	
		Stop, indicator, rear fog light, reverse light						
	P21/4W	BAZ15d	21/4 W	12 V	440/15 lm	8GD 178.560-031	G1789	
		Taillight, rear fog light						
	PY21W (Amber)	BAU15s	21 W	12 V	280 lm	8GA 006.841-121	G1121	
			21 W	24 V	280 lm	8GA 006.841-241	G1241	
		Long Life	21 W	24 V	280 lm	8GA 006.841-251	G6841LL	
		Indicator light						
	P21/5W	BAY15d	21/5 W	12 V	440/35 lm	8GD 178.560-111	G1142	
			21/5 W	24 V	440/40 lm	8GD 178.560-341	G334	
		Stoplight, taillight						
	P27W, SAE3156	W2.5x16d	27 W	12 V	475 lm	8GA 178.555-882	G5882	
			<div style="background-color: red; color: white; padding: 2px; display: inline-block;">COMING SOON</div>					
Stop, Indicator, rear fog light, reverse light								
	P27/7W, SAE 3157	W2.5x16q	27/7 W	12 V	475/36 lm	8GA 178.555-872	G5872	
			<div style="background-color: red; color: white; padding: 2px; display: inline-block;">COMING SOON</div>					
		Indicator						
	H21W	BAY9s	21 W	12 V	600 lm	8GH 008.417-001	G7010	
			21 W	24 V	600 lm	8GH 008.417-012	G7012	
		Indicator lights						



# STANDARD BULBS SUMMARY

## FOR CARS AND COMMERCIAL VEHICLES

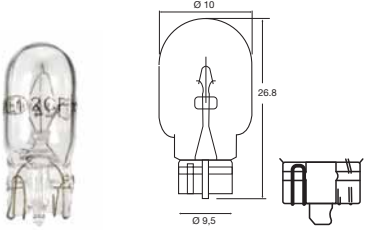
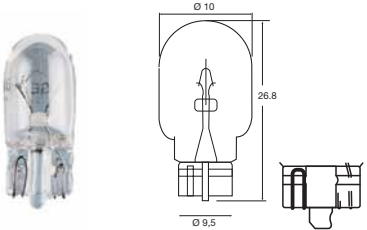
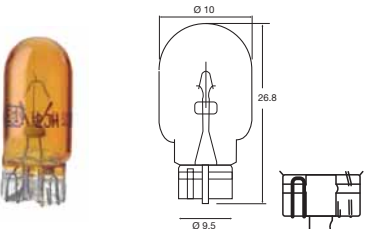
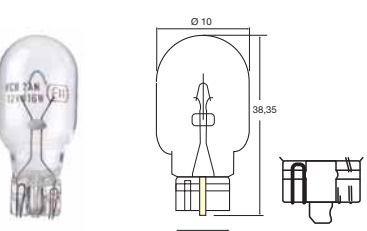
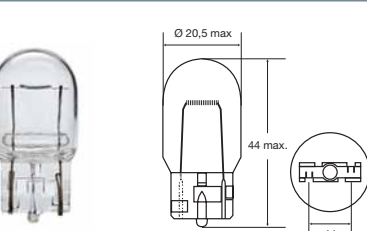
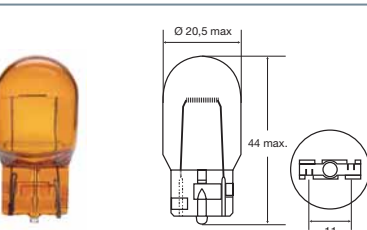
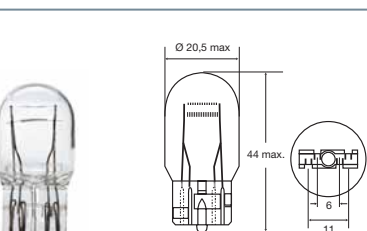
Product photo / Dimensional drawing	Category	Base	Power	Voltage	Luminous flux (lumen)	Part number	Short Code
	W3W	W2,1x9,5d	3 W	12 V	22 lm	8GP 003.594-141	G4141
			3 W	24 V	22 lm	8GP 178.560-351	G1793
Clearance light, license plate light							
	W5W	W2,1x9,5d	5 W	12 V	50 lm	8GP 178.560-081	G1790
			5 W	24 V	50 lm	8GP 178.560-271	G1788
Clearance light, license plate light							
	WY5W (Amber)	W2,1x9,5d	5 W	12 V	30 lm	8GP 003.594-541	G4541
		Position light, marker light					
	W16W	W2,1x9,5d	16 W	12 V	310 lm	8GA 008.246-001	G6001
		Position light					
	W21W	W3x16d	21W	12 V	460 lm	8GA 178.560-141	G6014
		Indicator, rear fog light, reverse light, taillight					
	WY21W (Amber)	W3x16d	21W	12 V	280 lm	8GP 009.021-002	G1002
		Indicator					
	W21/5W	W3x16q	21/5 W	12 V	440/35 lm	8GD 178.560-171	G6017
		Taillight					

# STANDARD BULBS SUMMARY

## FOR CARS AND COMMERCIAL VEHICLES

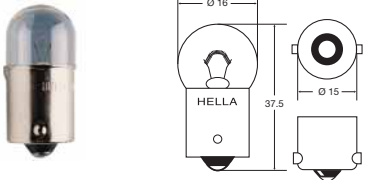
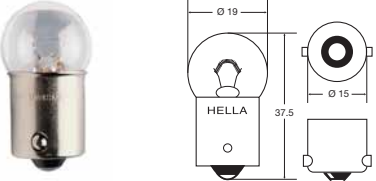
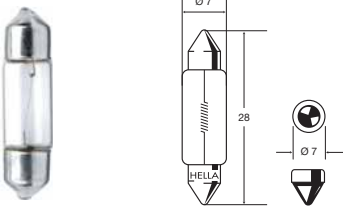
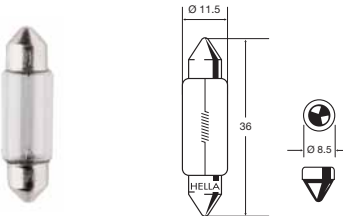
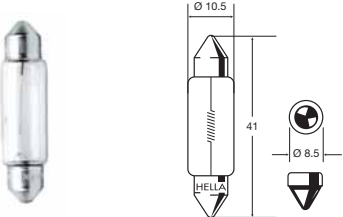
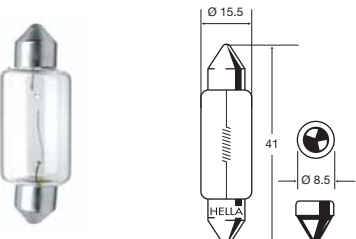
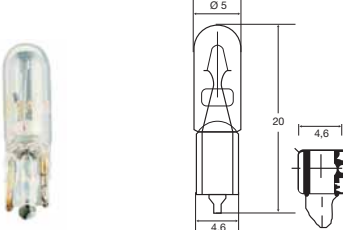
Product photo / Dimensional drawing	Category	Base	Power	Voltage	Luminous flux (lumen)	Part number	Short Code
	R5W	BA15s	5 W	12 V	50 lm	8GA 178.560-041	G207
			5 W	24 V	50 lm	8GA 178.560-361	G1304
		BA15d	5 W	12 V	50 lm	8GA 002.071-361	G1361
		License plate, clearance light, taillight, interior light					
	R10W	BA15s	10 W	12 V	125 lm	8GA 178.560-021	G613
			10 W	24 V	125 lm	8GA 178.560-241	G618
		License plate, clearance light, taillight, interior light					
	BULB, M	SV7-8	3 W	12 V	22 lm	8GM 002.094-121	G4121
			3 W	24 V	22 lm	8GM 002.094-241	G4241
		Indicator, stop, marker, position light					
	C5W	SV8.5-8	5 W	12 V	45 lm	8GM 002.092-121	G2121
			5 W	24 V	45 lm	8GM 002.092-241	G2241
		License plate, taillight, interior light					
	BULB, K	SV8.5-8	10 W	12 V	100 lm	8GM 002.091-131	G1131
			18 W	12 V	240 lm	8GM 002.091-121	G9112
			18W	24 V	240 lm	8GM 002.091-241	G9124
		Indicator, stop, taillight, reverse light (older versions)					
	BULB, K	SV8.5-8	10W	24 V	105 lm	8GM 002.091-251	G1251
		Indicator, stop, taillight, reverse light					
	BULB, 1.2W With clip	W2x4.6d	1.2 W	12 V	7.5 lm	8GP 178.560-061	G1791
			1.2 W	24 V	7.5 lm	8GP 178.560-251	G1792
		B8.5d	1.2 W	24 V	7.5 lm	8GA 007.997-071	G7071
		Instrument light, switch light					

# HIGH INTENSITY DISCHARGE BULBS (HID) FOR CARS AND COMMERCIAL VEHICLES



Gas discharge lamps are categorized according to their respective development version: D1, D2, D3 and D4. The "D" stands for "discharge".

The D1 lamps – the original Xenon burners – have an integrated ignition section. D2 lamps only consist on a socketed burner and unlike to all other versions no exterior protective glass bulb around the discharge tube.

The D3 and D4 lamps, are further developments of the D1 and D2 lamps and more environmentally compatible, as they don't use mercury.

**Please notice:** Due to different electrical parameters (42 V instead of 85 V arc voltage, with identical capacity), the D3 and D4 lamps cannot be used with the control units for D1 or D2 lamps.

**Features :**

- Very high luminous flux value.
- Longer service life with UV protection.
- Vibration resistant characteristics.
- Wider and far reaching illumination.
- Colour temperature near daylight.

Product photo / Dimensional drawing	Category	Base	Power	Voltage	Luminous flux (lumen)	Part number	Short Code
	D1S	PK32 d-2	35 W	12/24 V	3,200 lm	8GS 009.028-021	G8021
							Arc voltage = 85V
	D2S	PK32 d-2	35 W	12/24 V	3,200 lm	8GS 007.949-101	G7949
							Arc voltage = 85V
	D2R	PK32 d-3	35 W	12/24 V	2,800 lm	8GS 007.001-121	G7001
							Arc voltage = 85V
	D3S	P32d-2	35 W	12/24 V	3,200 lm	8GS 009.028-201	G9028
							Arc voltage = 42V
	D4S	PK32 d-5	35 W	12/24 V	2,800 lm	8GS 007.949-301	G9301
							Arc voltage = 42V
							Low beam in the 4-headlight system

# HIGH PERFORMANCE AUTOMOTIVE HALOGEN BULBS

## PRODUCT RANGE



### Colour coding Product Group

**LONG LIFE**

**DAYMAKER +80**

**NIGHT VISION +**

**PLATINUM +50**

**XENON BLUE**

### Part number abbreviations

LL	=	Long Life
NV	=	Night Vision +
PL	=	Platimun +50
DM	=	Daymaker +80
XB	=	Xenon Blue

# LIGHTING THE FUTURE

## HIGH PERFORMANCE HALOGEN BULBS

Basically high performance bulbs are halogen bulbs, but with improved characteristics to achieve better performance levels in answer to specific demands. All HELLA high performance bulbs meet the global standard (ECE R37 & SAE/DOT regulation).

### LONG LIFE

Especially designed bulbs with thicker filament and halogen mixing gas. This guarantees a longer life span and reduced the energy consumption.

As it combines unusual sturdiness and vibration resistance with convincing brightness and long service life, it is ideal for frequent use (e.g. trucks and the permanent use of daytime running lights).

### XENON BLUE

Halogen bulbs with a blue finish have also been available for some time now. In contrast to conventional halogen bulbs, these bulbs produce a bluish-white light (up to 4000 K) and are thus closer to the colour of daylight.

The light appears brighter and richer in contrast to the eye and has been designed to enable drivers to drive for longer without tiring. This impression is subjective, but nevertheless the xenon blue bulb is a definite design upgrade.

### PLATINUM +50 & DAYMAKER +80

H1, H4 and H7 are also available as “+50” or “+80”. These bulbs are advanced developments of conventional bulbs with thinner filament and inert gas filling. Due to this, they can be operated at higher temperatures and reach a higher luminance, up to 50% or 80% more between 50 and 100 meters in front of the vehicle. The range of illumination can also be increased by up to 40 meters.

The HELLA DAYMAKER is top of the range. With up to 80% more light on the road, up to 40 meters longer light beam and blue-coating for a colour temperature of about 3500K, they offer more driving safety at night and in adverse weather conditions.

### HIGH VISION+

These halogen bulbs have a special yellow-ring coating at filament position and emit a soft and yellowish light (about 3000 K) for a more comfortable driving experience, especially in wet weather conditions. (This impression is subjective.)

### HID LAMPS

High-intensity discharge lamps generate light according to the physical principle of electrical discharge.

The luminous flux, light output, luminance and service life are significantly better than with halogen bulbs. They also reach a higher colour temperature near daylight and offer a wider and far reaching illumination.

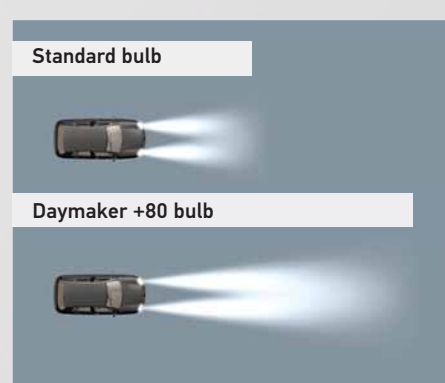

Schematic illustration: Comparison of a standard halogen bulb and a high performance +80 halogen bulb.



# LONG LIFE

## LIFE SPAN: FOR A LONGER LIFE SPAN

The special design of Long Life bulbs for passenger cars guarantees a longer service life, more light performance and reduced energy consumption, making them ideal for frequent drivers and permanent use of daytime running lights.

Long Life represents bright but glare-free light. Good performance under extreme conditions encountered by construction





machinery or off-road vehicles. Long Life combines unusual sturdiness and vibration resistance with convincing brightness and long service life.

In addition, the longer service life halves the costs for spare parts and downtime.

### Features:

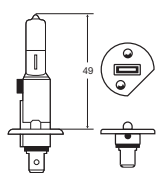
- More 200% longer life time than standard bulbs.
- Specially designed by halogen mixing gas & filament.
- Meets global standard (ECE R37 & SAE/DOT regulation).

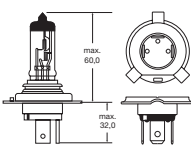
Plastic case includes 2 pieces

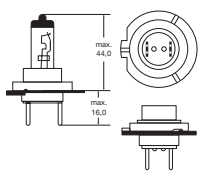
Product photo	Dimensional drawing	Product designation	Base	Power	Voltage	Colour temperature	Part number	Short part number
		H1 LONG LIFE P14.5s		70 W	24 V	3200K	8GH-178555-412	G5412LL
		Single replacement					8GH 178.555-413	G5412LL1
		H4 LONG LIFE P43t		75/70 W	24 V	3200K	8GJ-178555-432	G5432LL
		Single replacement					8GJ 178.555-433	G5432LL1
		H7 LONG LIFE PX26d		70 W	24 V	3200K	8GH-178555-442	G5442LL
		Single replacement					8GH 178.555-443	G5442LL1



# NIGHT VISION +



Plastic case includes 2 pieces

## YELLOW-RING COATING TECHNOLOGY

Thanks to our up-to-date technology, HELLA Night Vision performance bulbs light up the roadway more than standard bulbs.

The optimised illuminant and a special coating process used on the glass bulb enhances vision and therefore improves the reaction time.

### Features:

- Special yellow-ring coating at filament position.
- Delivers yellowish and soft light towards driving direction.
- Meets global standard (ECE R37 & SAE/DOT regulation).

Product photo	Dimensional drawing	Product designation	Base	Power	Voltage	Colour temperature	Part number	Short part number
		H4 NIGHTVISION +	P43t	60/55 W	12 V	3000K	8GJ-178555-472	G5472NV
		Single replacement					8GJ 178.555-473	G5472NV1
		H7 NIGHTVISION +	PX26d	55 W	12V	3000K	8GH-178555-482	G5482NV
		Single replacement					8GH 178.555-483	G5482NV1



# PLATINUM +50







Plastic case includes 2 pieces

## PERFORMANCE: FOR MORE LIGHT

The Platinum +50 version produces 50 percent more light (compared to standard bulbs) and extends the light cone by around 20 meters, giving performance-oriented drivers additional safety time in case of an emergency situation.

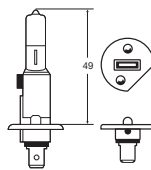
### Features:

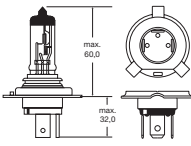
- Delivers 50% more light on the road.
- Up to 20 meters longer light beam compared to standard bulbs.
- Meets global standard (ECE R37 & SAE/DOT regulation).

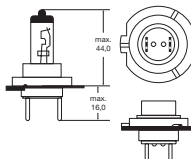
Product photo	Dimensional drawing	Product designation	Base	Power	Voltage	Colour temperature	Part number	Short part number
		H1 PLATINUM +50	P14.5s	55 W	12 V	3200K	8GH-178555-052	G5051PL
		Single replacement					8GH 178.555-053	G5051PL1
		H4 PLATINUM +50	P43t	60/55 W	12 V	3200K	8GJ-178555-492	G5492PL
		Single replacement					8GJ 178.555-493	G5492PL1
		H7 PLATINUM +50	PX26d	55 W	12 V	3200K	8GH-178555-502	G5502PL
		Single replacement					8GH 178.555-503	G5502PL1





Plastic case includes 2 pieces







# DAYMAKER +80

## MORE POWER

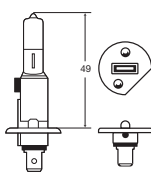
The optimised illuminant and a special coating process used on the glass bulb allows the Daymaker +80 version to achieve up to 80 percent more light than comparable standard halogen bulbs, giving drivers more driving pleasure and maximum safety.

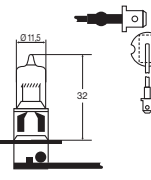
### Features:

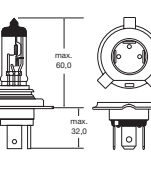
- Delivers 80% more light on the road.
- Up to 40 meters longer light beam compared to standard bulbs.
- Special blue-coating deliver white & clear lights.
- Meets global standard (ECE R37 & SAE/DOT regulation).

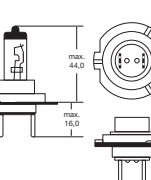
Product photo	Dimensional drawing	Product designation	Base	Power	Voltage	Colour temperature	Part number	Short part number
		H1 DAYMAKER+80	P14.5s	55 W	12 V	3500K	8GH-178555-532	G5532DM
		Single replacement					8GH 178.555-533	G5532DM1
		H3 DAYMAKER+80	PK22s	55 W	12 V	3500K	8GH-178555-512	G5512DM
		Single replacement					8GH 178.555-513	G5512DM1
		H4 DAYMAKER+80	P43t	60/55 W	12 V	3500K	8GJ-178555-542	G5542DM
		Single replacement					8GJ 178.555-543	G5542DM1
		H7 DAYMAKER+80	PX26d	55 W	12 V	3500K	8GH-178555-552	G5552DM
		Single replacement					8GH 178.555-553	G5552DM1



# XENON BLUE



Plastic case includes 2 pieces







## DESIGN: FOR INCREASED DEMANDS

Special demands on design and driving safety are met by our modern design bulbs. With its cool xenon effect, Xenon Blue light is a real alternative for design-oriented drivers. Thanks to the high 4000K temperature, similar to a xenon bulb, the Xenon Blue version provides up to 20 percent more brightness.

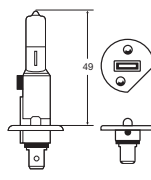
The whitish-blue light ensures better illumination, driving comfort and safety.

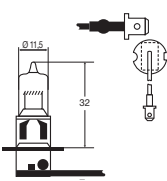

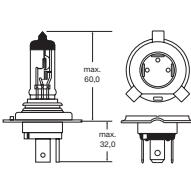

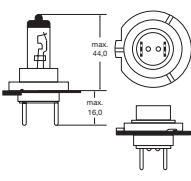
### Features:

- Brilliant 4000K white daylight.
- Sharper view and better concentration.
- Meets global standard (ECE R37 & SAE/DOT regulation).

Product photo	Dimensional drawing	Product designation	Base	Power	Voltage	Colour temperature	Part number	Short part number
		H1 XENON BLUE P14.5s		55 W	12 V	4000K	8GH-178555-172	G5171XB
		Single replacement					8GH-178.555-173	G5171XB1
		H3 XENON BLUE PK22s		55 W	12 V	4000K	8GH 178.555-072	G5072XB
		Single replacement					8GH-178.555-071	G1787XB1
		H4 XENON BLUE P43t		60/55 W	12 V	4000K	8GJ-178555-122	G5121XB
		Single replacement					8GJ-178.555-123	G5121XB1
		H7 XENON BLUE PX26d		55 W	12 V	4000K	8GH-178555-572	G5572XB
		Single replacement					8GH-178.555-573	G5572XB1

# HIGH PERFORMANCE AUTOMOTIVE HALOGEN BULBS

## PRODUCT RANGE

	H1	H3	H4	H7	VOLTS
 <p><b>LONG LIFE</b> Brilliant 3200K white light, 50% more light and harmonised light colour.</p>	G5412LL	-	G5432LL	G5442LL	24V
 <p><b>NIGHT VISION+</b> Special yellow-ring coating at filament position</p>	-	-	G5472NV	G5482NV	12V
 <p><b>PLATINUM +50</b> Offers 50% more light and 20m longer light beam compared to standard bulbs.</p>	G5051PL	-	G5492PL	G5502PL	12V
 <p><b>DAYMAKER +80</b> Offers 80% more light and 40m longer light beam compared to standard bulbs.</p>	G5532DM	G5512DM	G5542DM	G5552DM	12V
 <p><b>XENON BLUE</b> Brilliant 4000K white light, light colour harmonised with HID in effect &amp; colour.</p>	G5171XB	G5072XB	G5121XB	G5572XB	12V

High Performance Bulbs

HELLA high performance bulbs offer optimum quality and are best suited to individual demands.

The reliable and cost effective bulbs lead the way to a future with better vision and more safety on the road.

- » Longer life time.
- » Sharp view and better concentration.
- » Maximum safety and visibility.
- » Optimised premium filament design.
- » Stylish and powerful lights on the road.



**HELLA Automotive South Africa (Pty) Ltd.**

P O Box 6130  
Moselville, Uitenhage,  
SOUTH AFRICA  
6230

**Sales Telephone:** +27 (0) 41 996 5700

**Sales Telefax:** +27 (0) 41 996 5720

<http://www.hella.co.za>

© HELLA KGaA Hueck & Co., Lippstadt

PN: Z9023 07.2012

Printed in South Africa

[www.hella.co.za](http://www.hella.co.za)

Follow us on:  
[www.facebook.com/hellasouthafrica](http://www.facebook.com/hellasouthafrica)

